

NPN General Purpose Amplifier

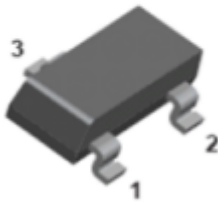
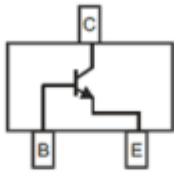

SOT-23

Features

- Moisture sensitivity level 1
- Halogen free and RoHS compliant
- Surface mount package ideally suited for automatic insertion

Application

- Signal amplification
- Switching circuit

Mechanical data

- **Package:** SOT-23
- **Terminals:** Tin plated leads, solderable per J-STD-002 and JESD22-B102

■ Maximum Ratings (T_a=25°C Unless otherwise specified)

Item	Symbol	Unit	Conditions	Value
Device marking code			2SC2411-Q	ANQ
			2SC2411-R	ANR
Collector-base voltage	V _{CBO}	V	I _C =100μA, I _E =0	40
Collector-emitter voltage	V _{CEO}	V	I _C = 1mA, I _B =0	32
Emitter-base voltage	V _{EBO}	V	I _E =100μA, I _C =0	5
Collector current	I _C	A		0.5
Power dissipation	P _D	mW		200
Junction temperature	T _J	°C		-55 to +150
Storage temperature	T _{STG}	°C		-55 to +150



2SC2411

RoHS
COMPLIANT

■ Electrical Characteristics (T_a=25°C Unless otherwise specified)

Item	Symbol	Unit	Conditions	Min	Typ	Max
Collector-base breakdown voltage	V _{(BR)CBO}	V	I _C =100μA, I _E =0	40		
Collector-emitter breakdown voltage	V _{(BR)CEO}	V	I _C =1mA, I _B =0	32		
Emitter-base breakdown voltage	V _{(BR)EBO}	V	I _E =100μA, I _C =0	5		
Collector-base cut-off current	I _{CBO}	uA	V _{CB} =20V			0.1
Emitter-base cut-off current	I _{EBO}	uA	V _{EB} =4V			0.1
DC current gain	h _{FE}		2SC2411-Q	V _{CE} =3V, I _C =100mA	120	270
			2SC2411-R		180	390
Collector-emitter saturation voltage	V _{CE(sat)}	V	I _C =500mA, I _B =50mA			0.6
Transition frequency	f _T	MHz	V _{CE} =5V, I _C =20mA, f=100MHz		250	
Collector-base output capacitance	C _{ob}	pF	V _{CB} =10V, I _E =0A, f=1MHz		3	

■ Thermal Characteristics

Parameter	Symbol	Unit	Value
Thermal resistance, junction-to-ambient	R _{θJ-A} ⁽¹⁾	°C/W	625
Thermal resistance, junction-to-case	R _{θJ-C} ⁽¹⁾	°C/W	500

Note:

(1) Device mounted on PCB, single-sided copper, with standard footprint



■ Characteristics

Fig 1: Static Characteristics

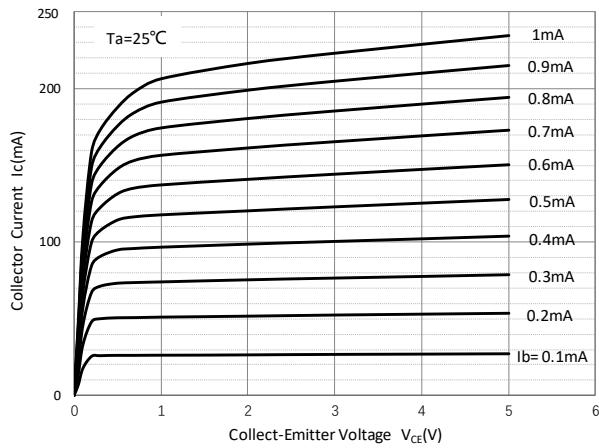

Fig 2: DC Current Gain

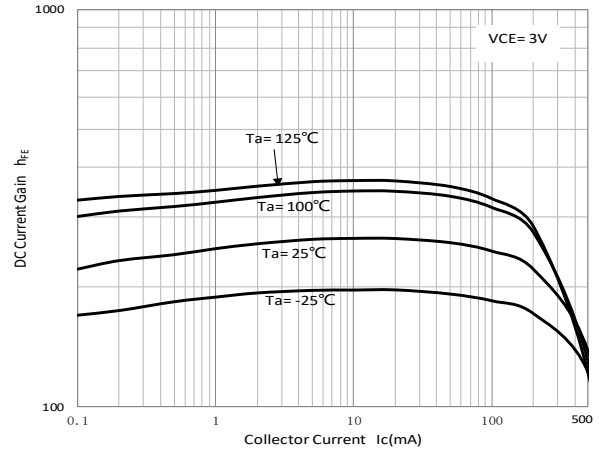

Fig 3: Collector-Emitter Saturation Voltage

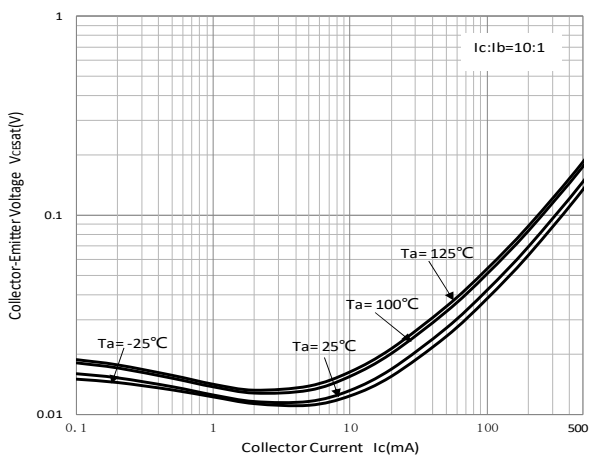

Fig 4: Base-Emitter Saturation Voltage

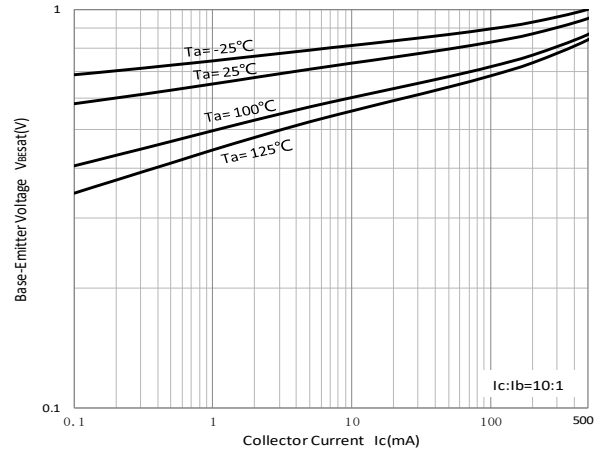

Fig 5: Base-Emitter On Voltage

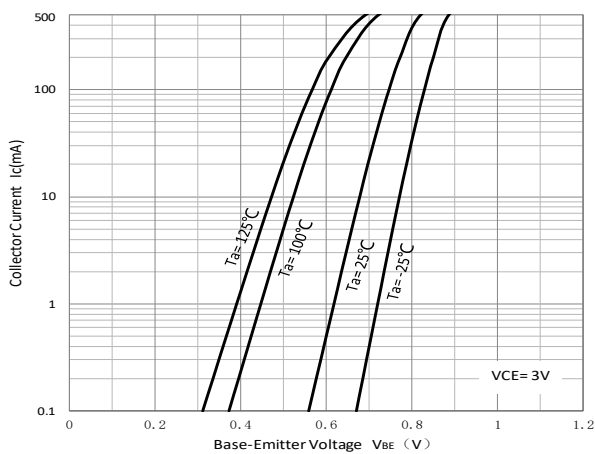

Fig 6: Cob/Cib-V_{CB}/V_{EB}

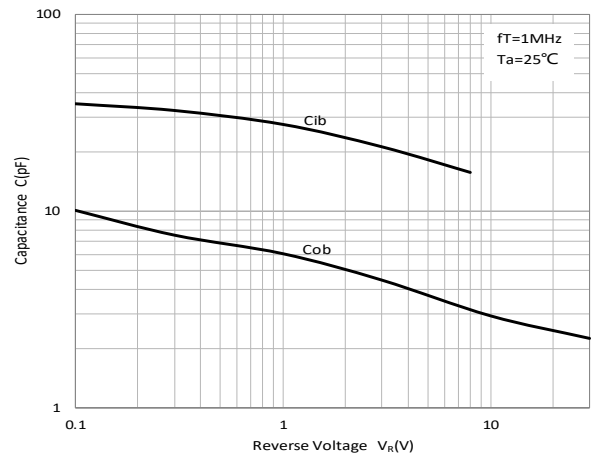
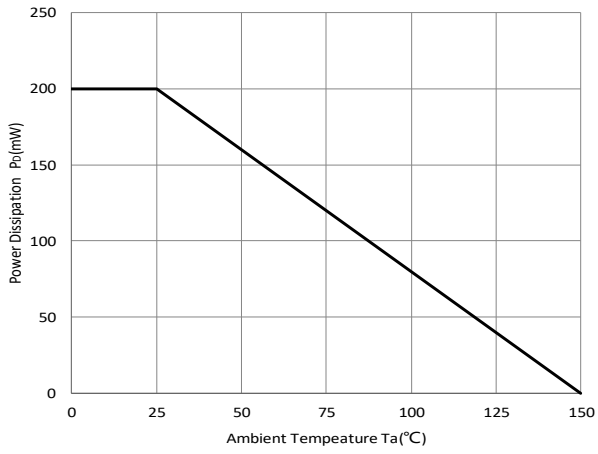



Fig 7: P_D - T_a Curve





■ Ordering Information

Preferred P/N	Packing code	Unit weight(g)	Minimum package(pcs)	Inner box quantity(pcs)	Outer carton quantity(pcs)	Delivery mode
2SC2411	F2	Approximate 0.008	3000	30000	120000	7" reel
2SC2411	F4	Approximate 0.008	10000	/	210000	13" reel

■ Outline Dimensions

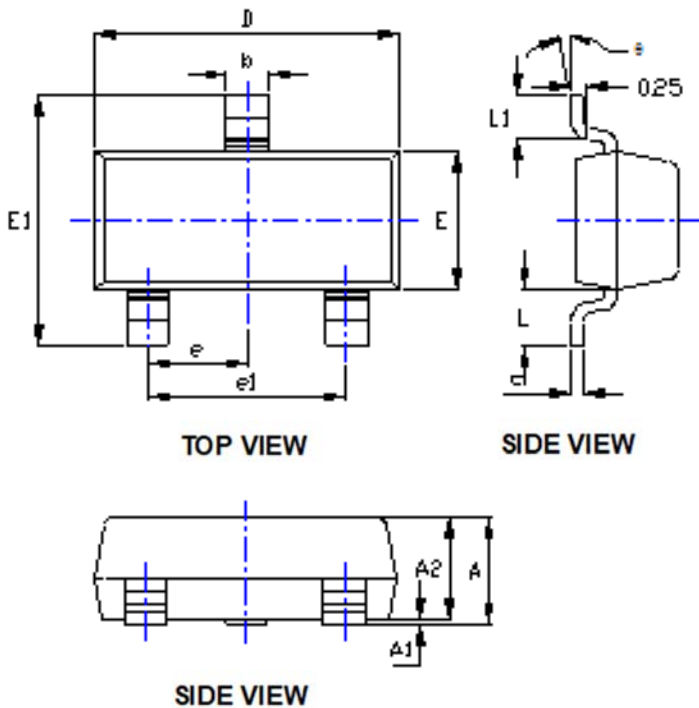

SYMBOL	DIMENSIONS			
	INCHES		Millimeter	
	MIN.	MAX.	MIN.	MAX.
A	0.035	0.045	0.900	1.150
A1	0.000	0.004	0.000	0.100
A2	0.035	0.041	0.900	1.050
b	0.012	0.020	0.300	0.500
c	0.004	0.008	0.100	0.200
D	0.110	0.118	2.800	3.000
E	0.047	0.055	1.200	1.400
E1	0.089	0.100	2.250	2.550
e	0.037TYP		0.950TYP	
e1	0.071	0.079	1.800	2.000
L	0.022REF		0.550REF	
L1	0.012	0.020	0.300	0.500
θ	0°	8°	0°	8°

■ Suggested Pad Layout

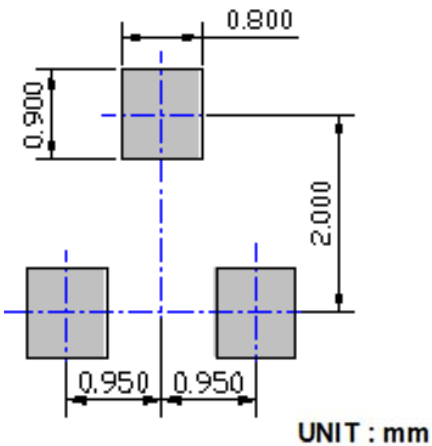



Disclaimer

The information presented in this document is for reference only. Yangzhou Yangjie Electronic Technology Co., Ltd. reserves the right to make changes without notice for the specification of the products displayed herein to improve reliability, function, or design or otherwise.

The product listed herein is designed to be used with ordinary electronic equipment or devices, and not designed to be used with equipment or devices which require high level of reliability and the malfunction of which would directly endanger human life (such as medical instruments, transportation equipment, aerospace machinery, nuclear-reactor controllers, fuel controllers and other safety devices), Yangjie or anyone on its behalf, assumes no responsibility or liability for any damages resulting from such improper use of sale.

This publication supersedes & replaces all information previously supplied. For additional information, please visit our website [http:// www.21yangjie.com](http://www.21yangjie.com) , or consult your nearest Yangjie's sales office for further assistance.